

310501B003

PL: Szafka 1xdrzwi z szybą
EN: Cabinet 1xdoor with glass
FR: Armoire 1xporte avec vitre
DE: Gartenschrank 1xTür mit Fenster

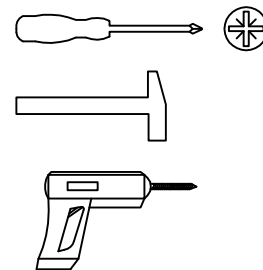

Zestaw montażowy! Fixing parts! Kit de montage! Montageset!

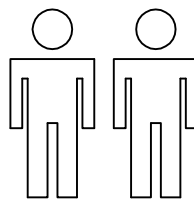
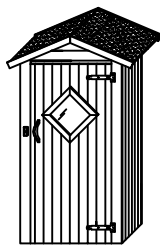
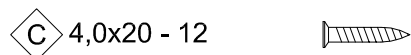
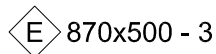
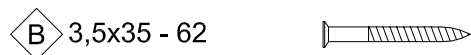
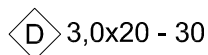
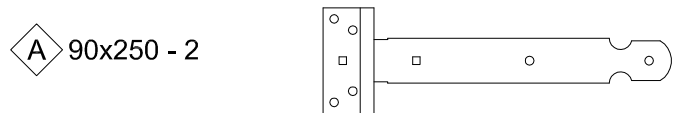

UWAGA! ATTENTION! ACHTUNG!

PL: Przed montażem należy utwardzić i wypoziomować podłogę.

Zaleca się nawiercenie otworów pod wkręty!

EN: Before assembling there is need to toughen and nivelier the basis.

For all screws we advise to pre-bore the holes!

FR: Avant le montage, il est conseillé de tasser et de niveler le sol.

Pour tous les assemblages à l'aide des vis, nous vous conseillons de faire des pré-perçages.

DE: Vor der Montage verfestigen und nivellieren Sie bitte den Boden.

Vor dem Schraubeneindreihen soll man die Locher bohren!

1

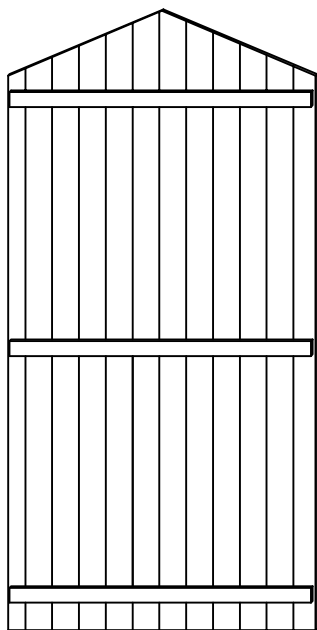

2

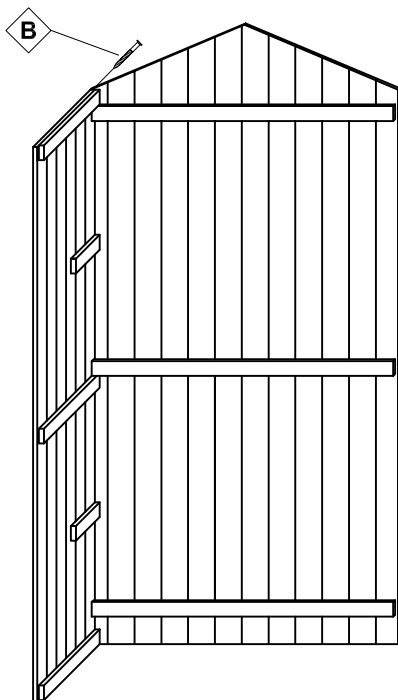

3

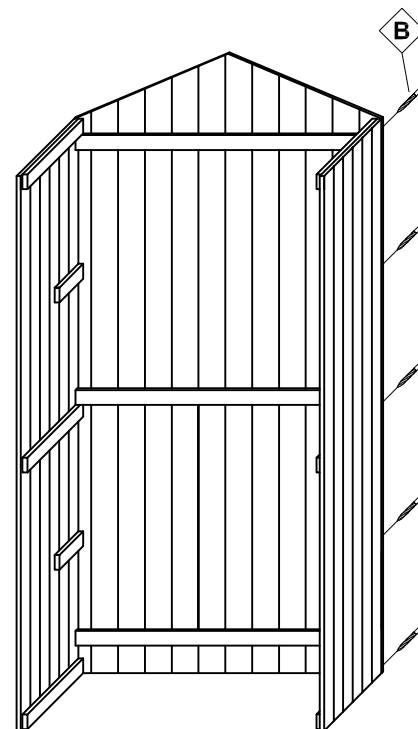

4

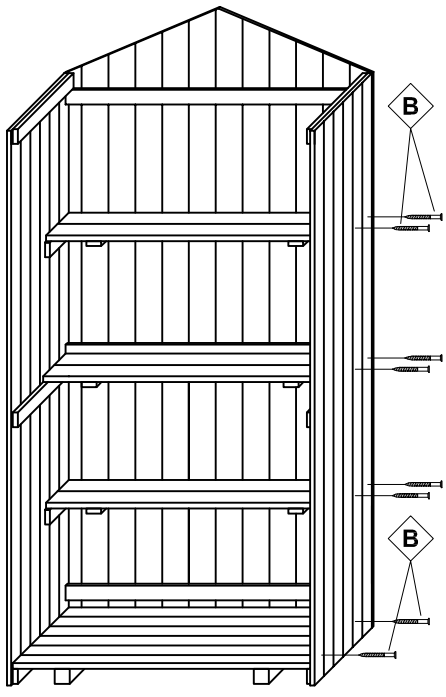

5

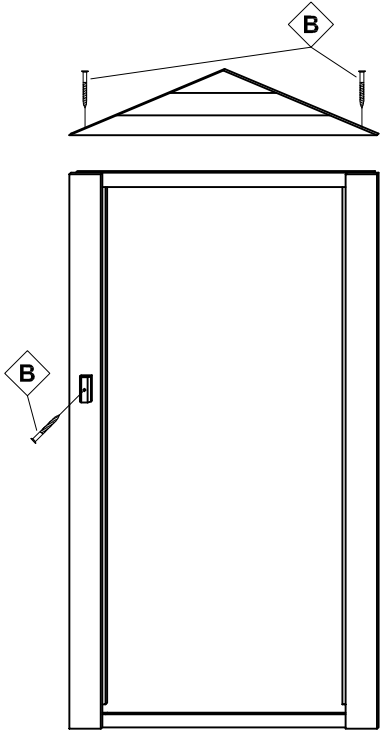

6

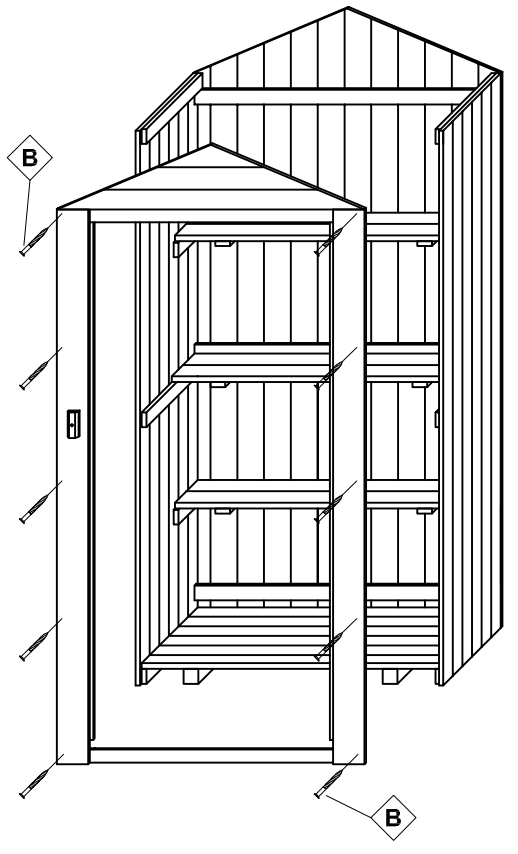

7

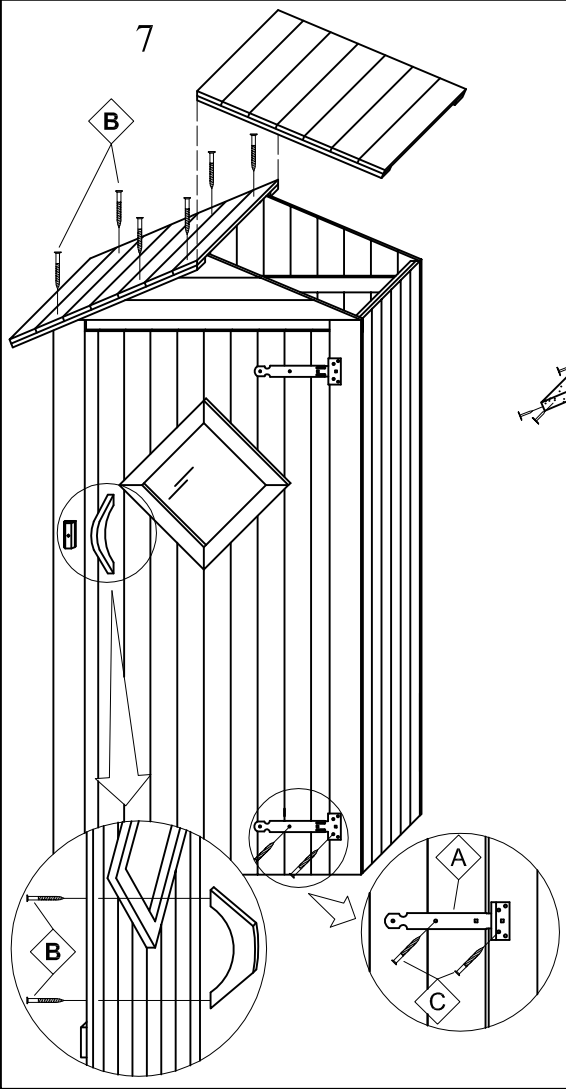

8

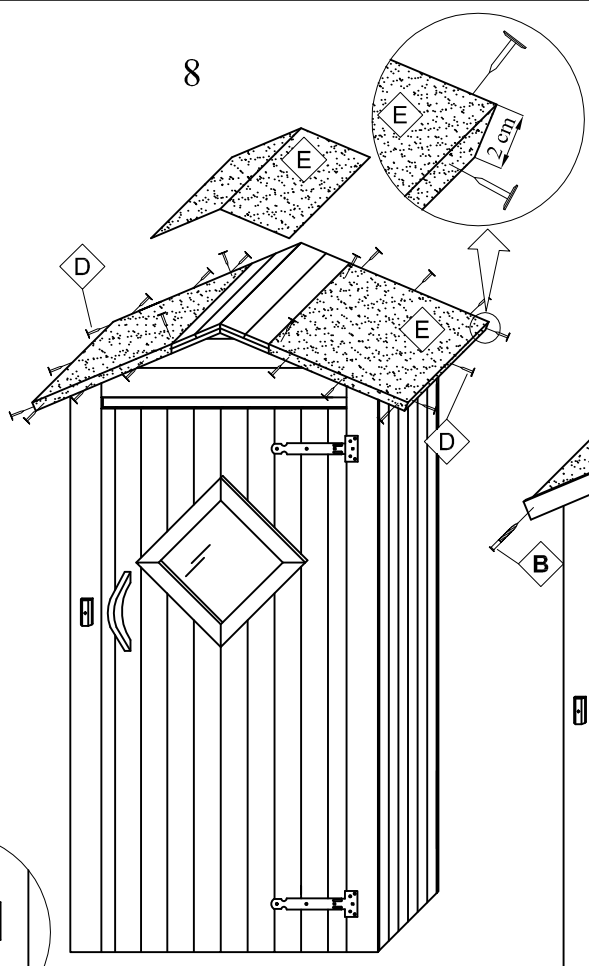

9

