

Regały 3+1 do domku MAXI

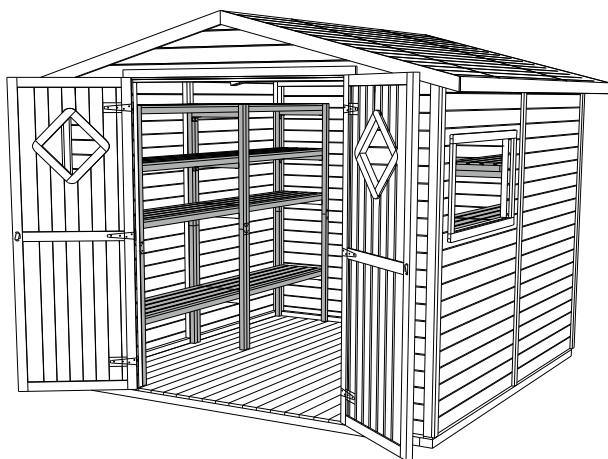

Zestaw montażowy.

A - kątownik

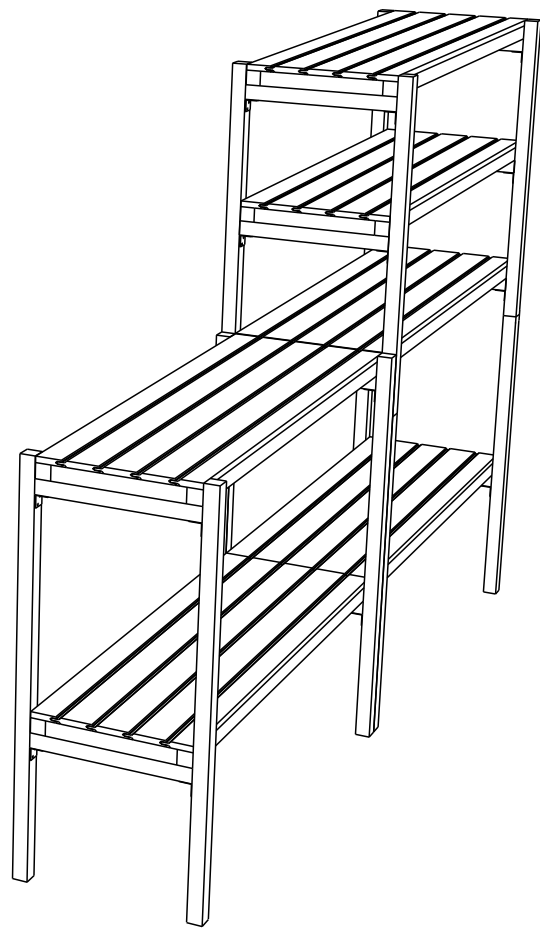
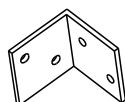

56 sztuk

B - płaskownik

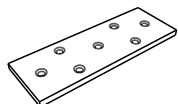

3 sztuki

C - wkręt 3,0x30



242 sztuki

D - wkręt 4,0x60



79 sztuk

UWAGA.

Zaleca się nawiercenie otworów pod wkręty.

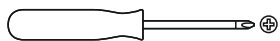
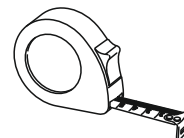
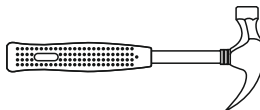
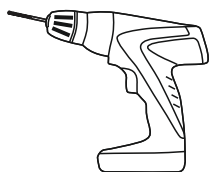
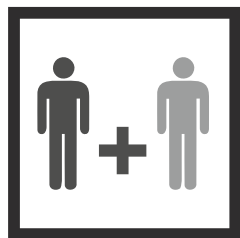

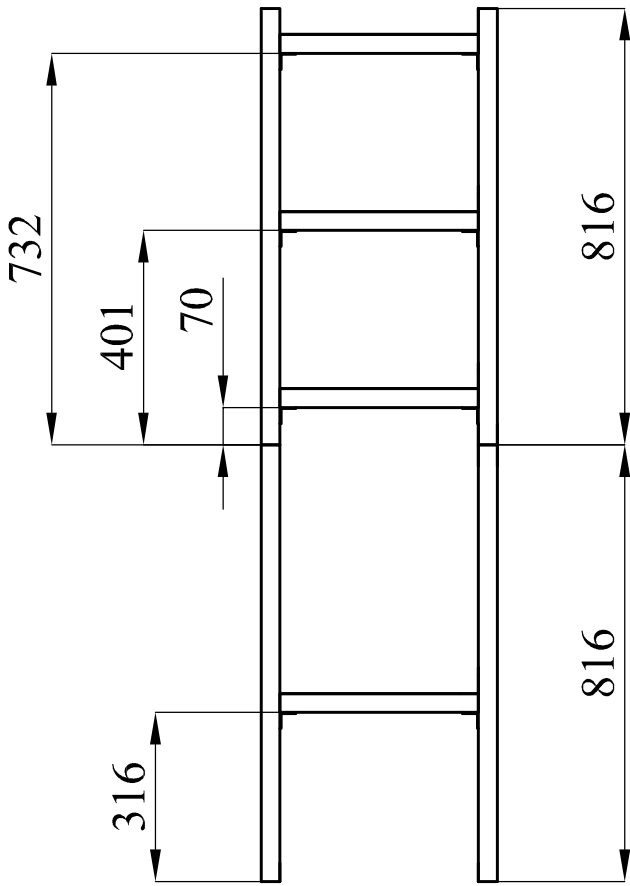
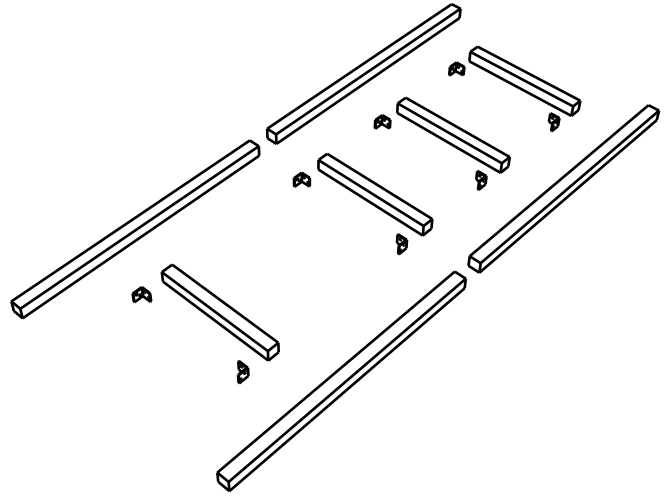
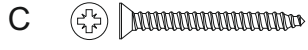
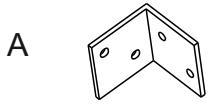

x6

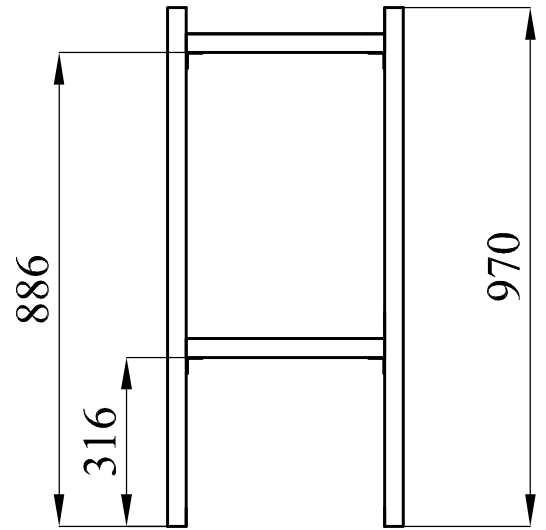

x2

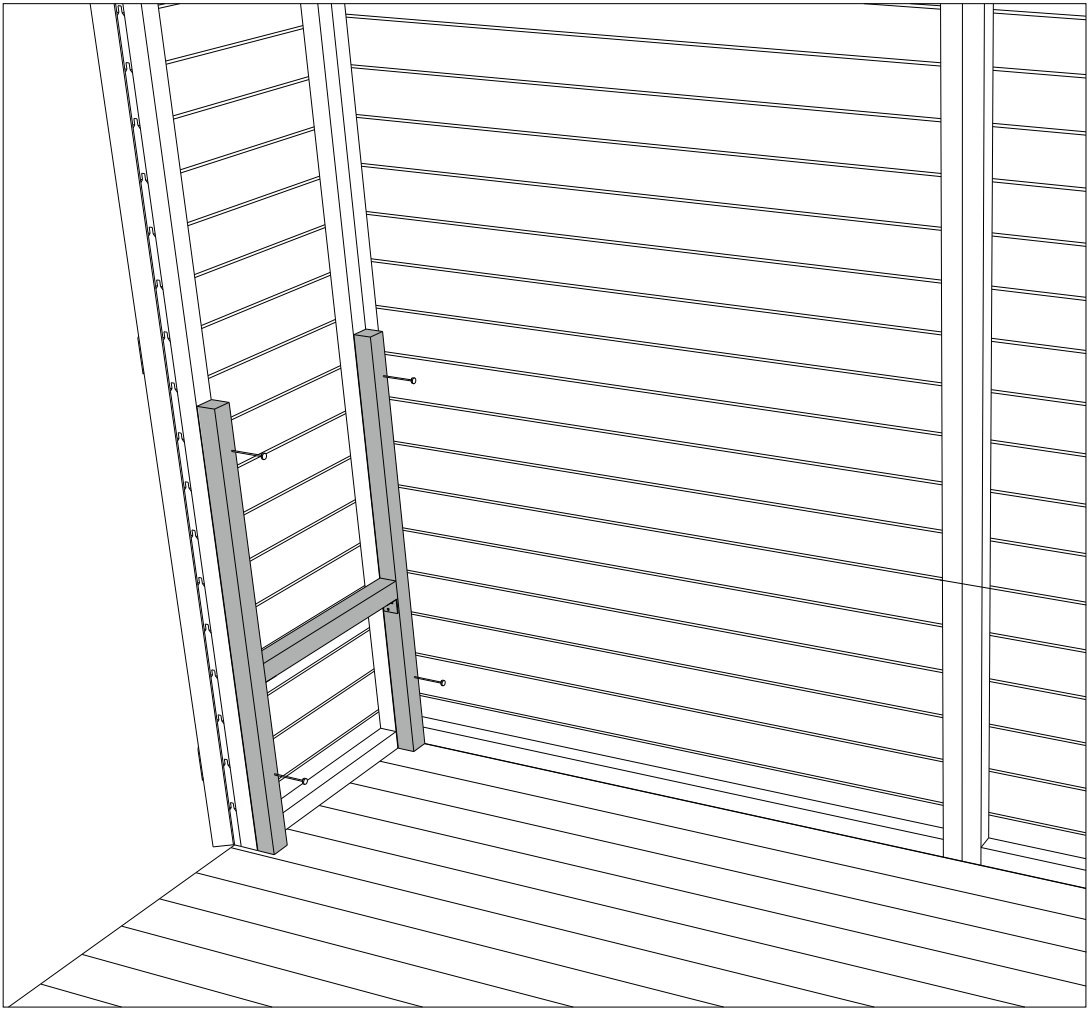

D

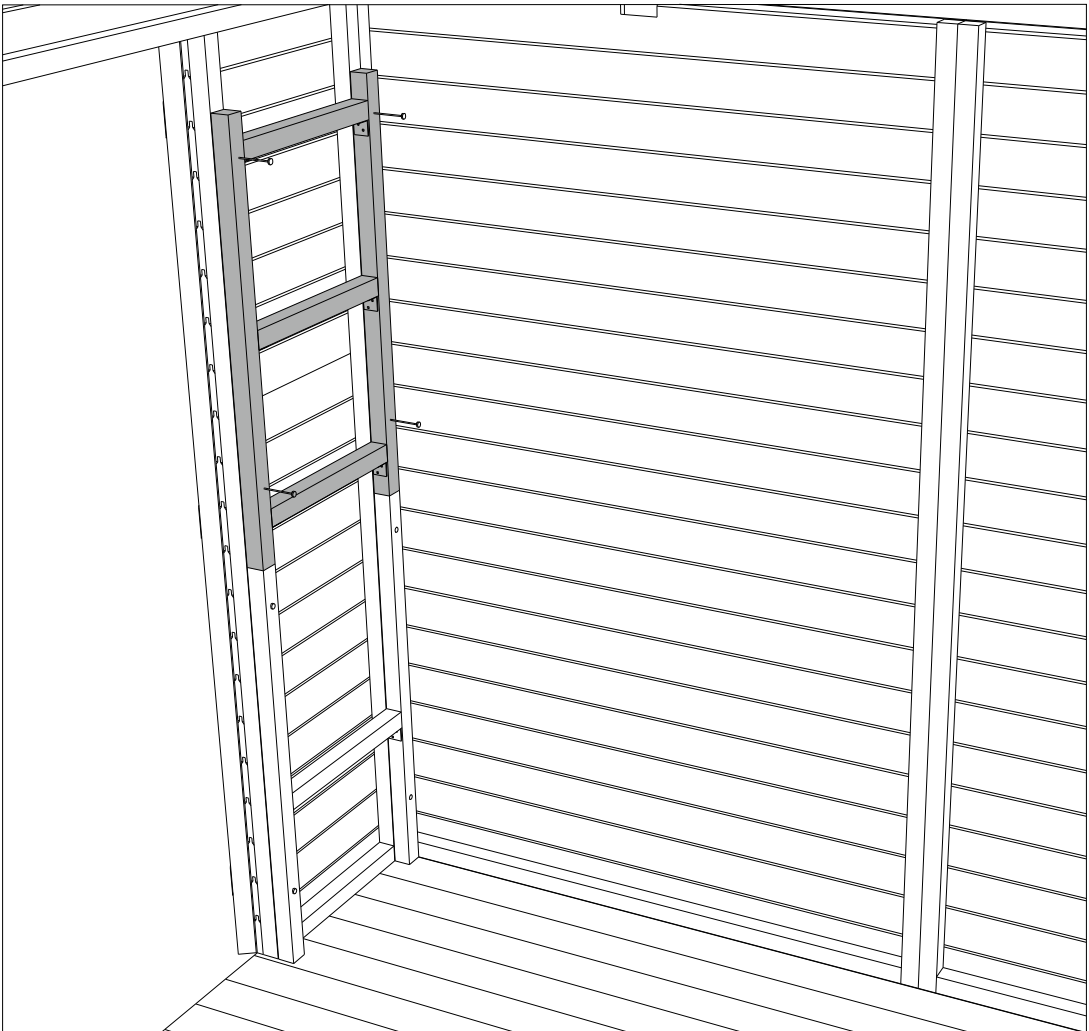

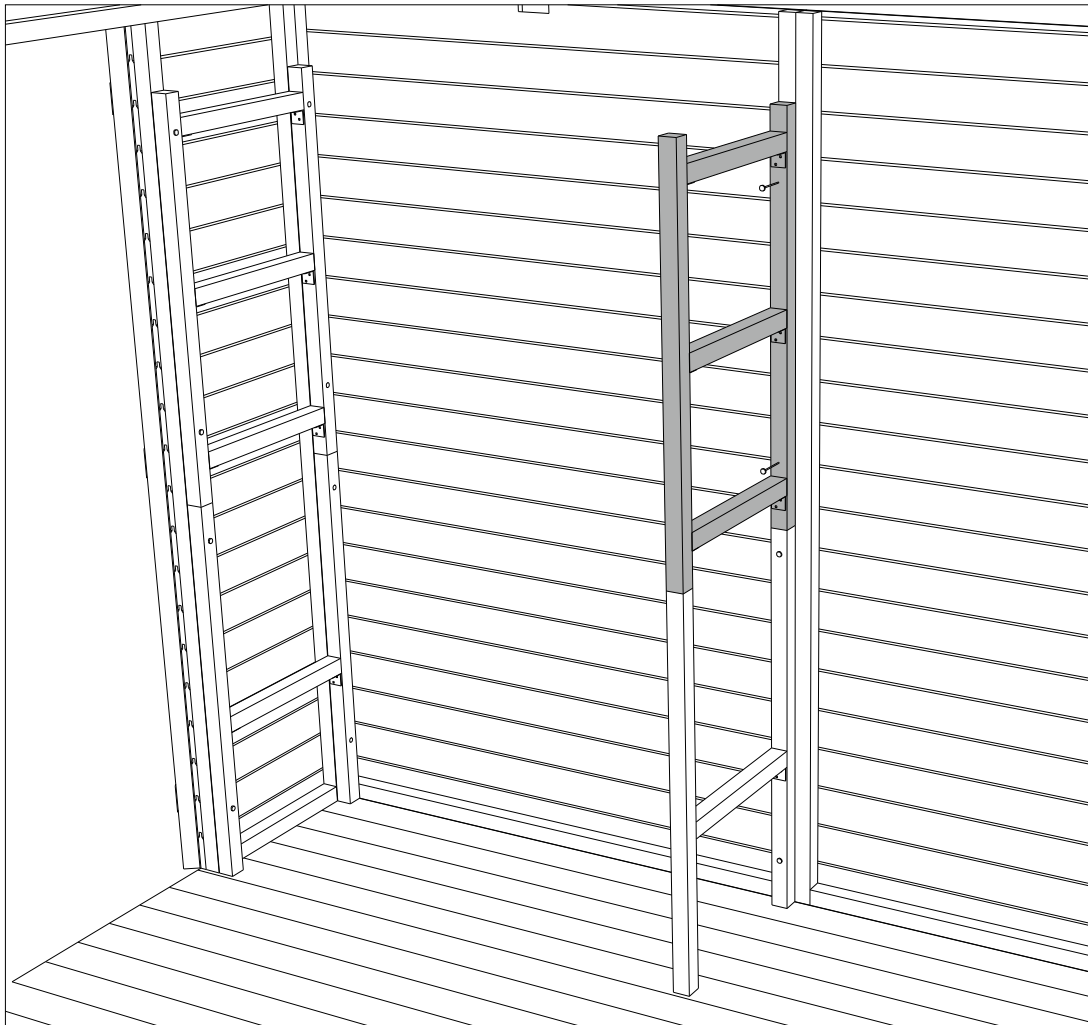
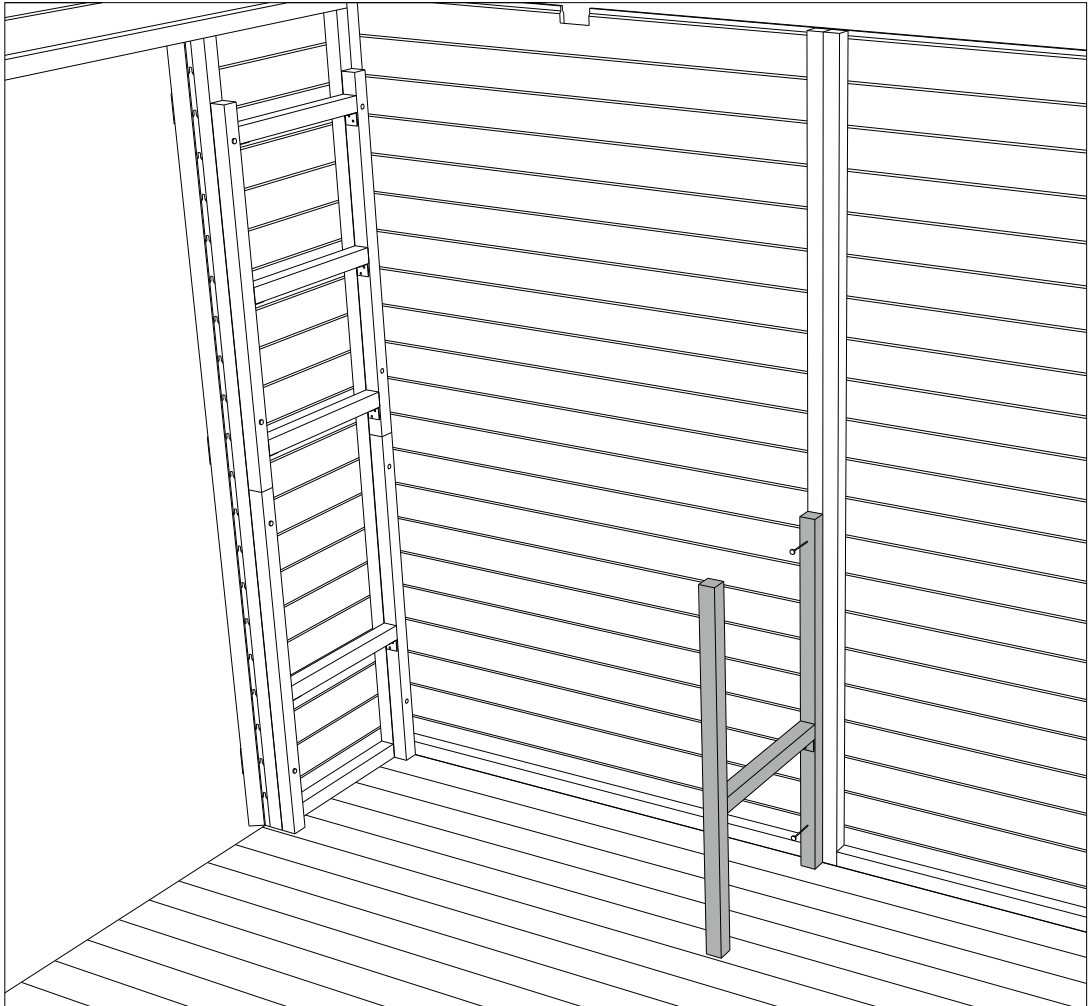

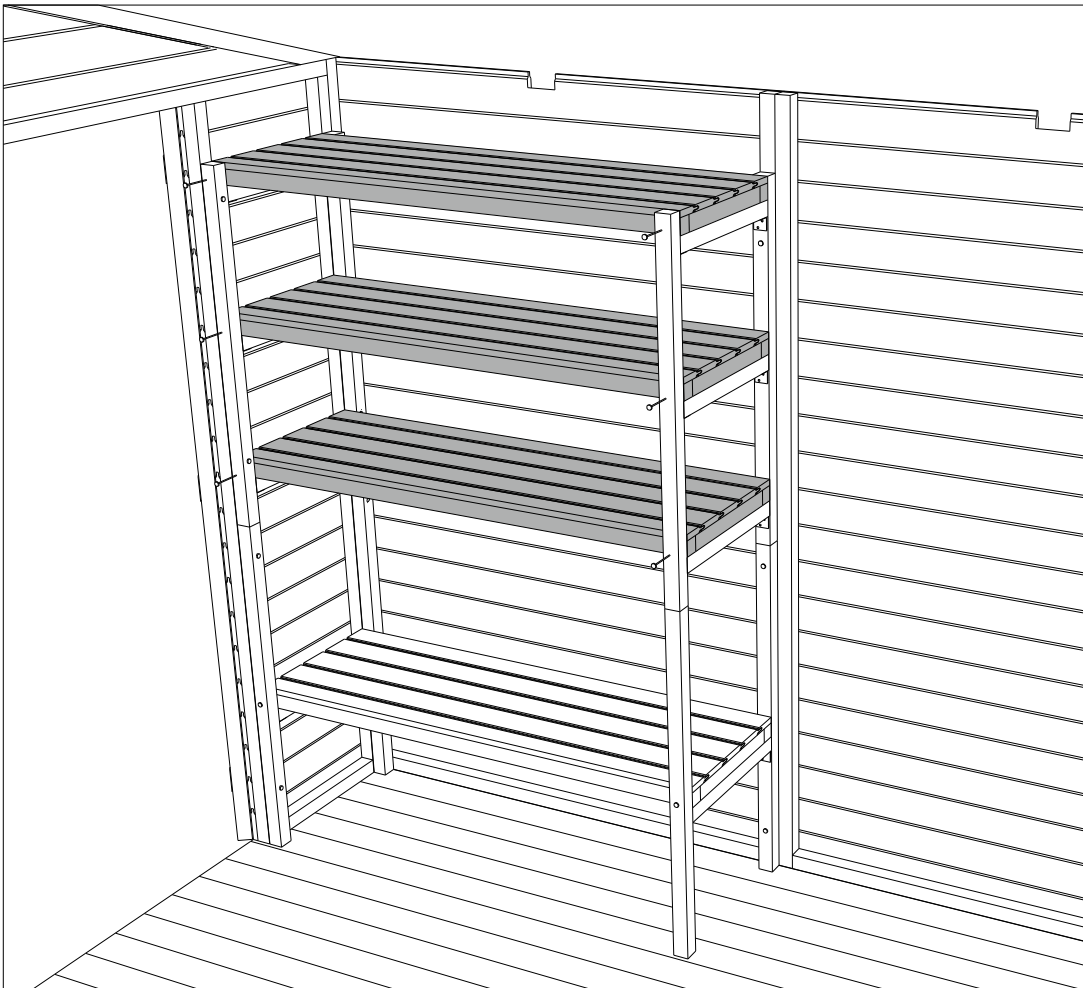
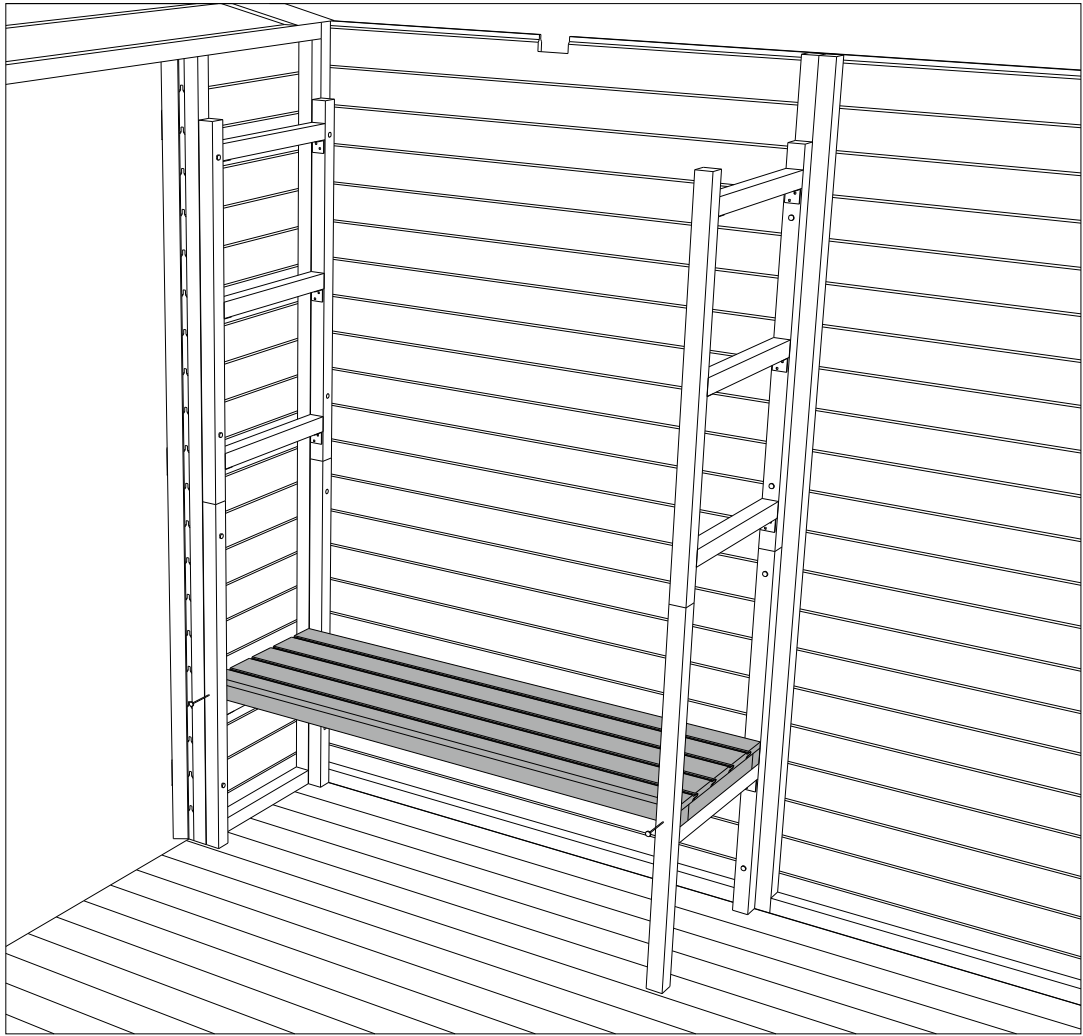

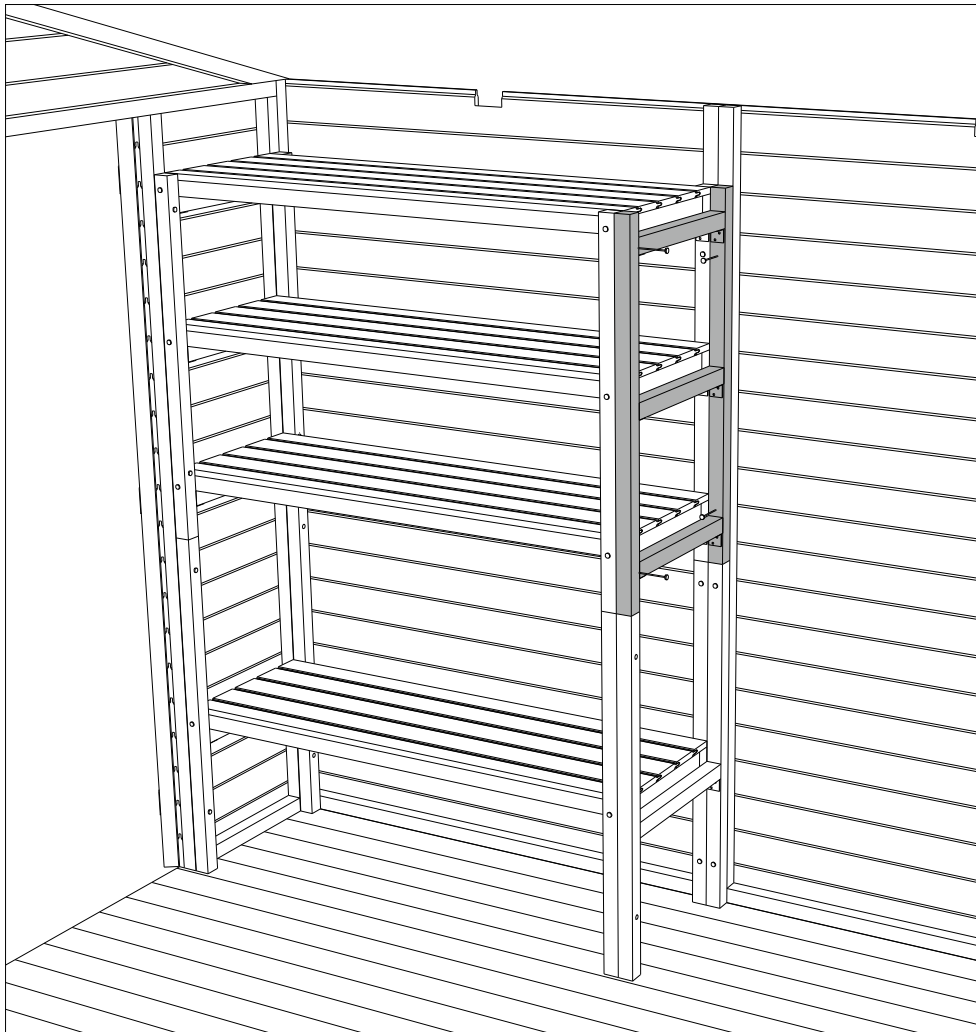
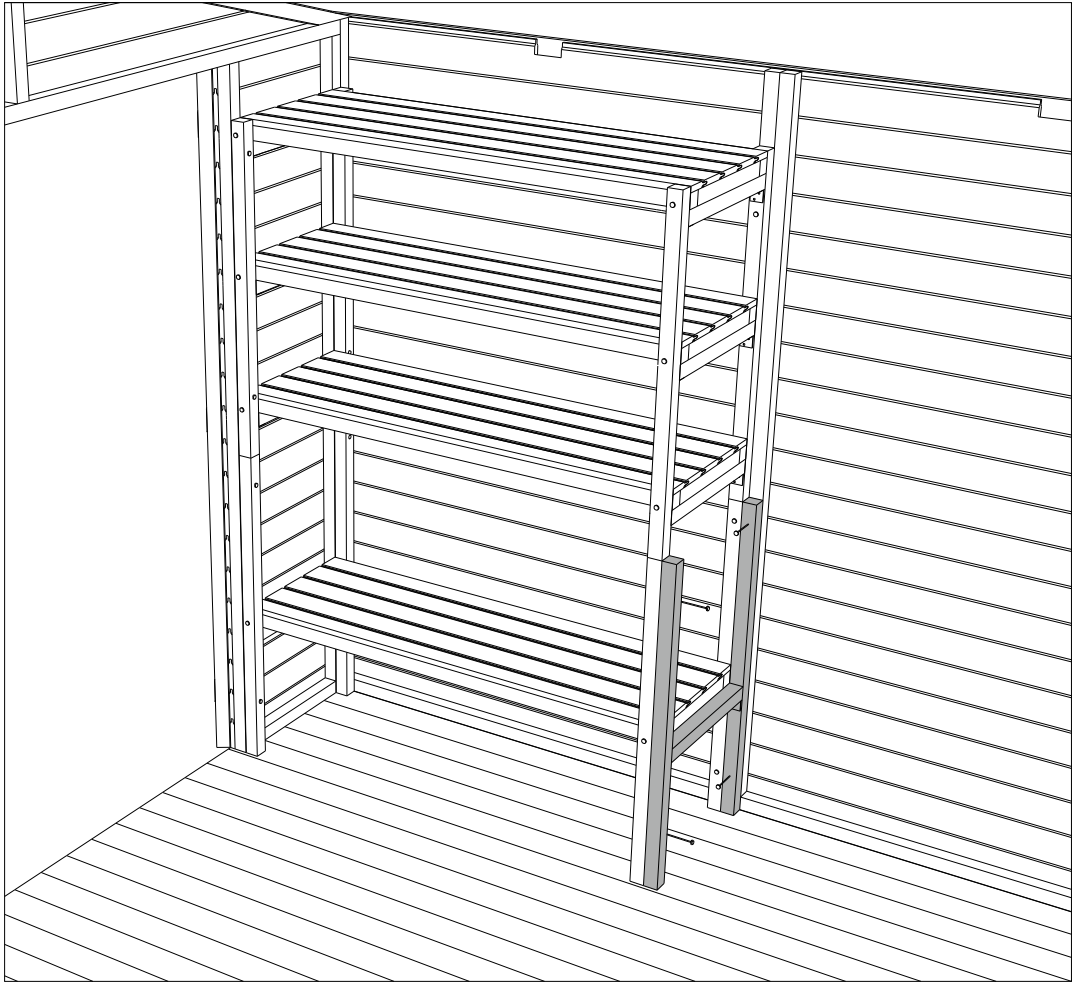

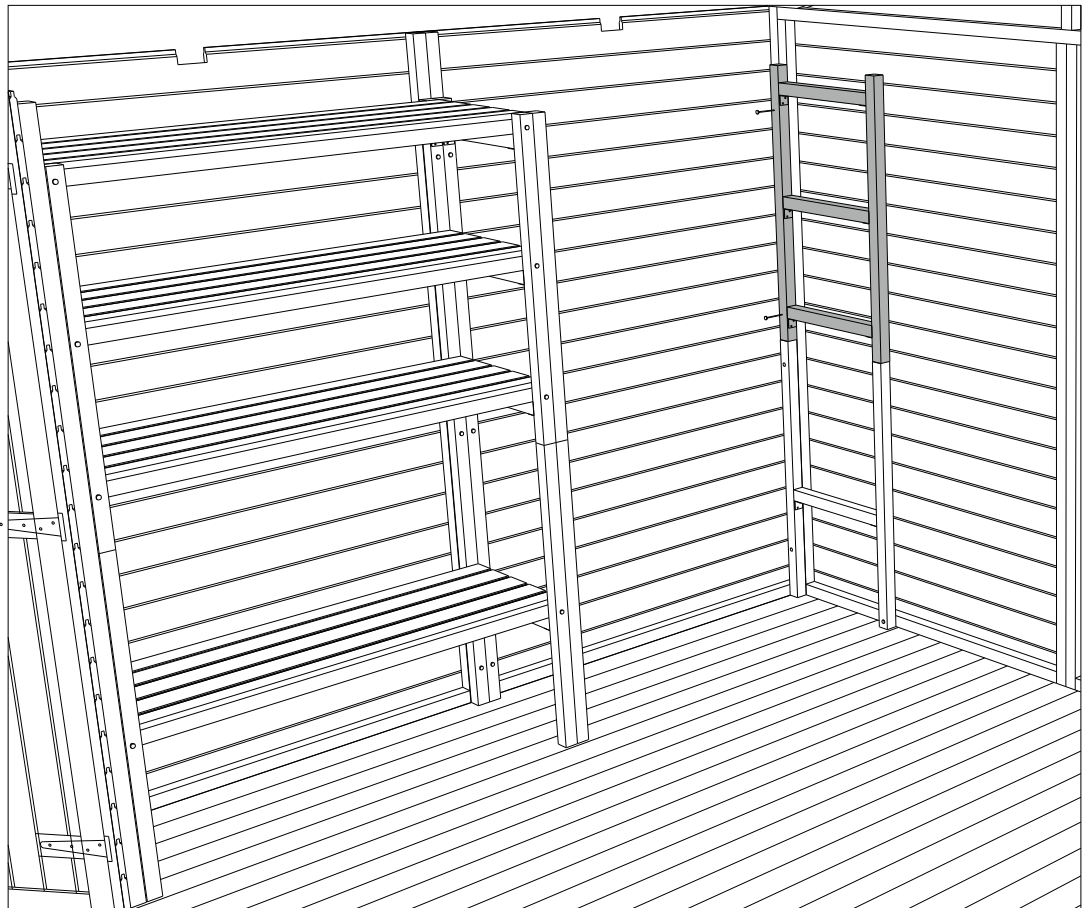
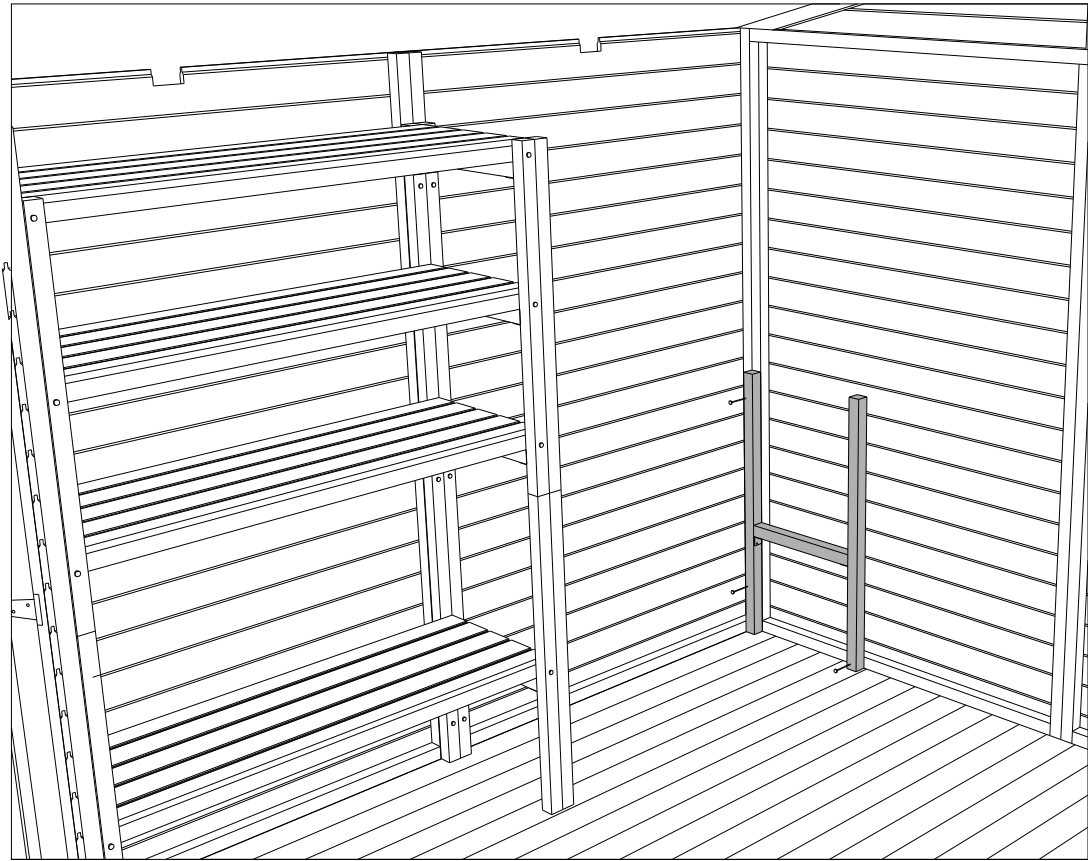

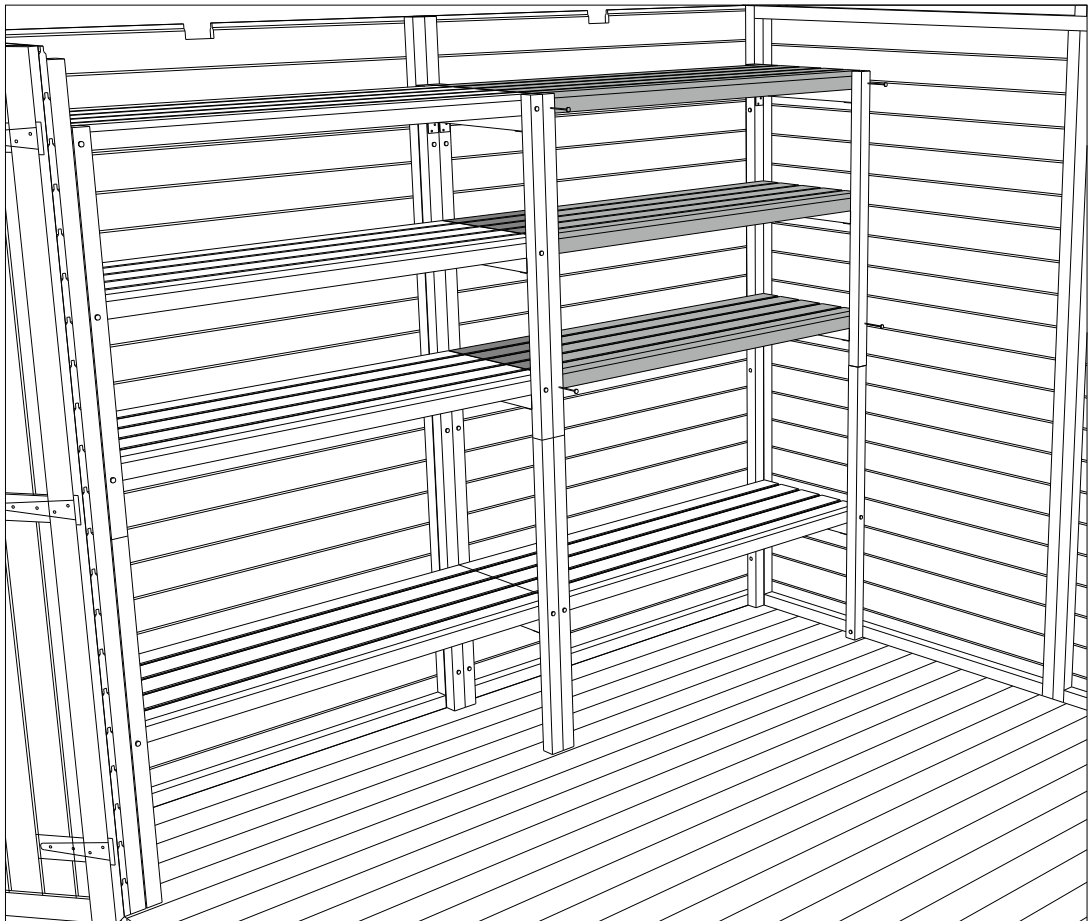
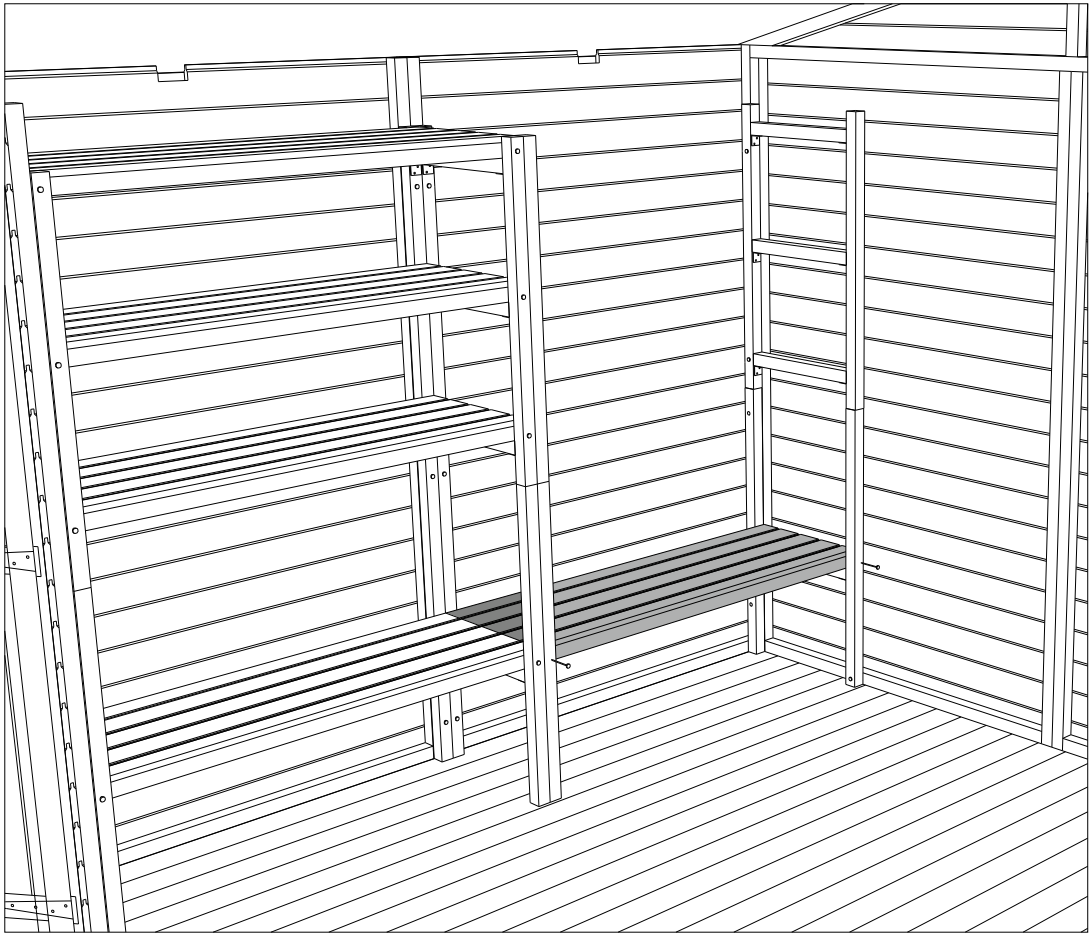

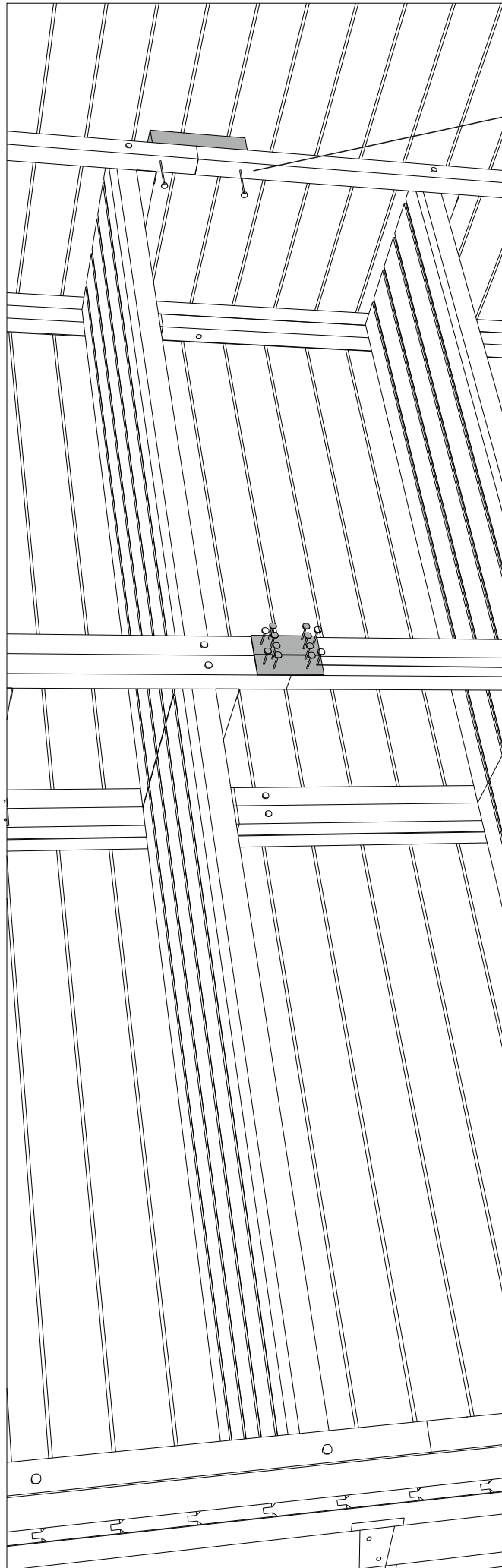

D

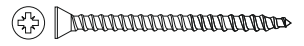

C



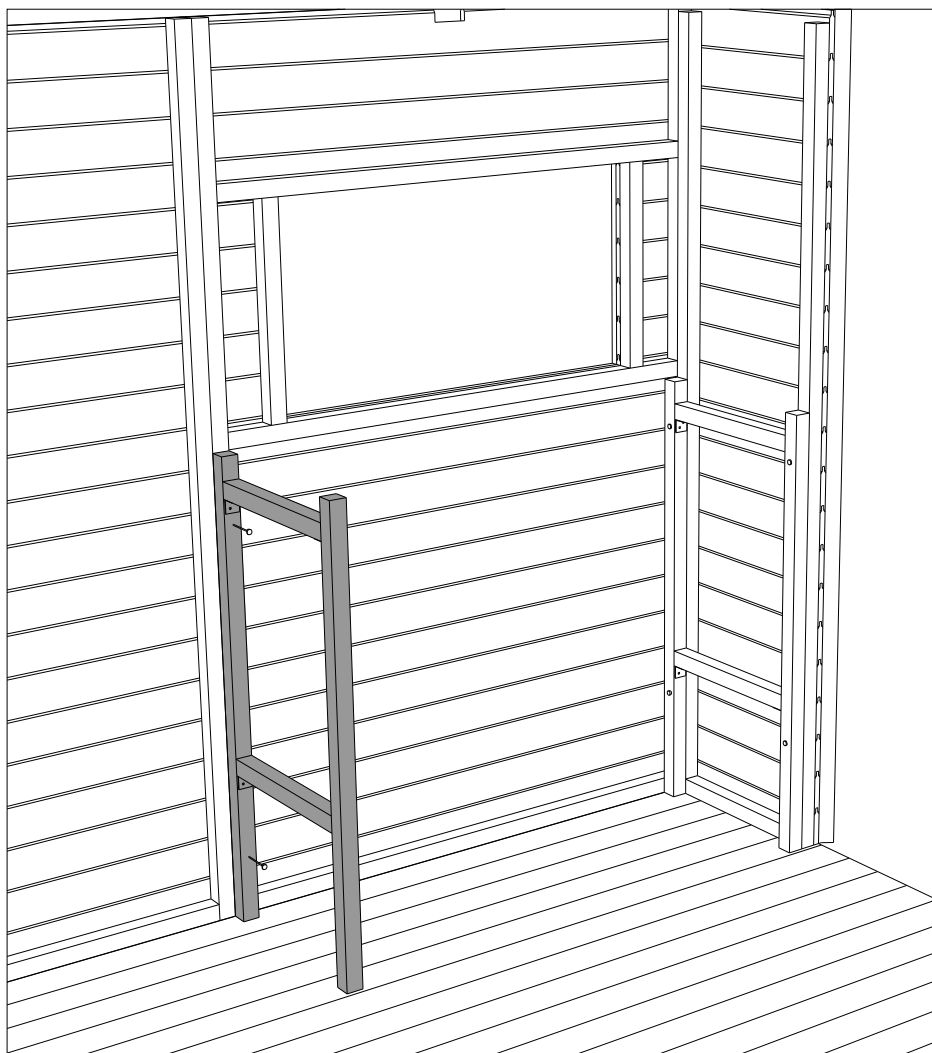
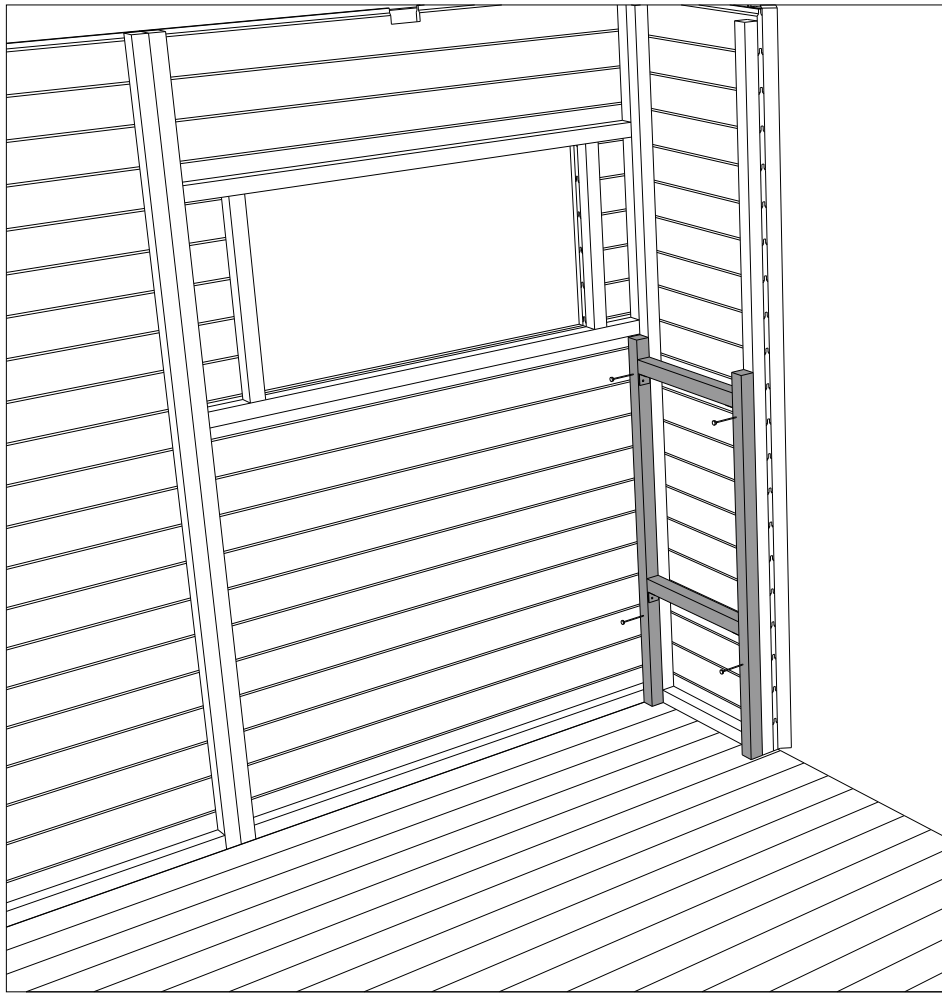

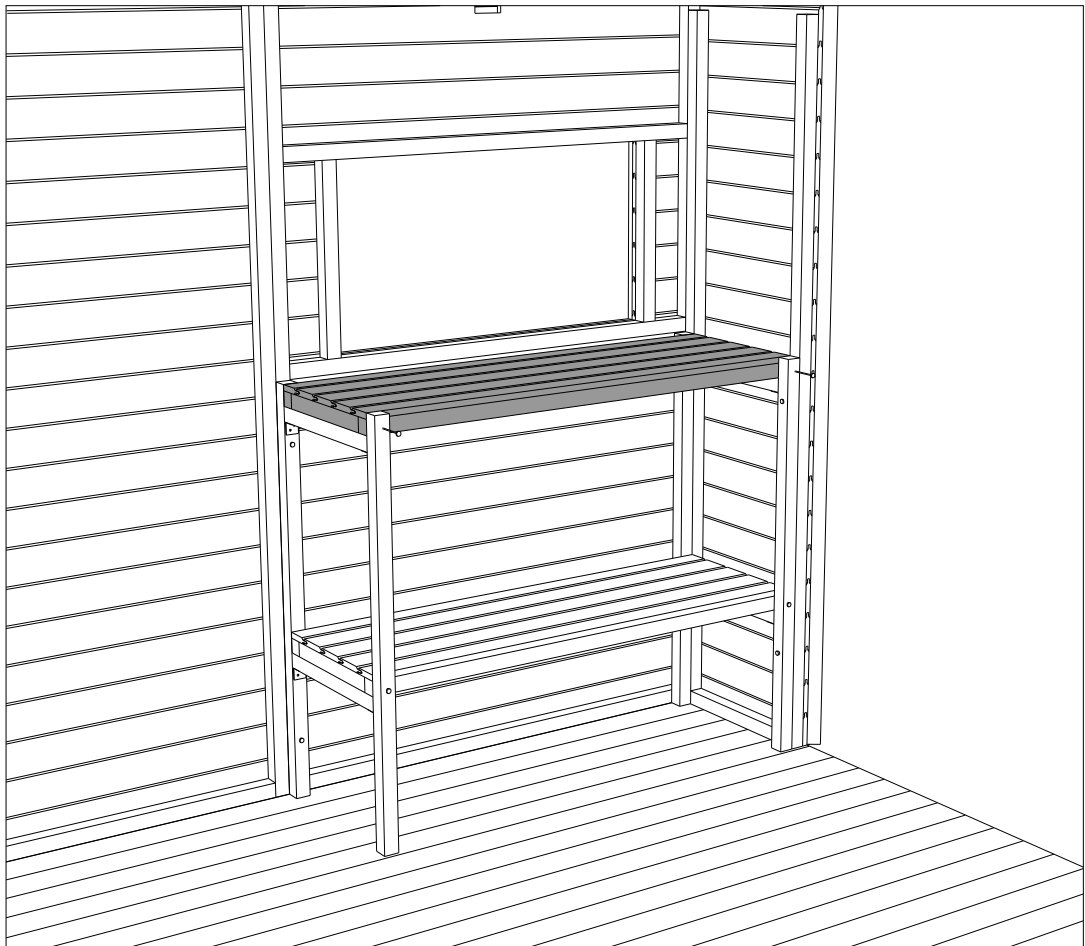
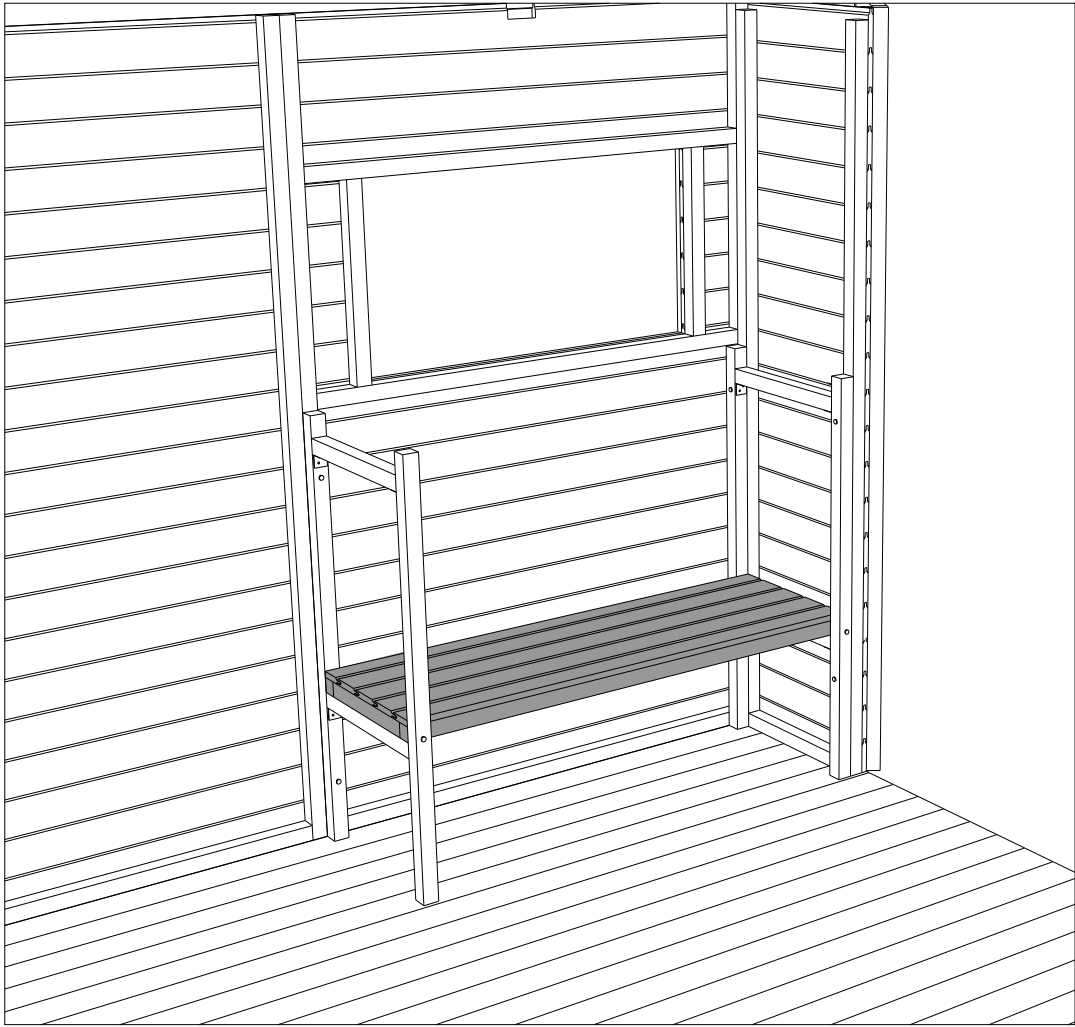

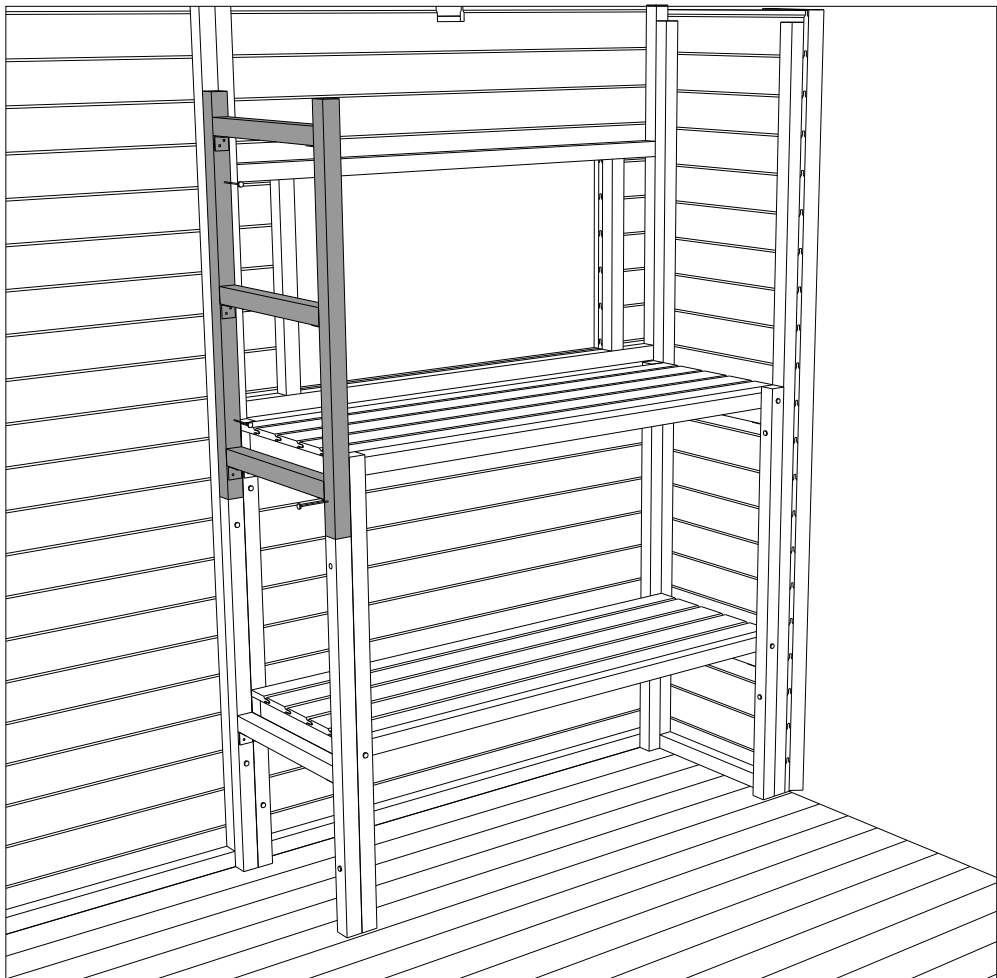
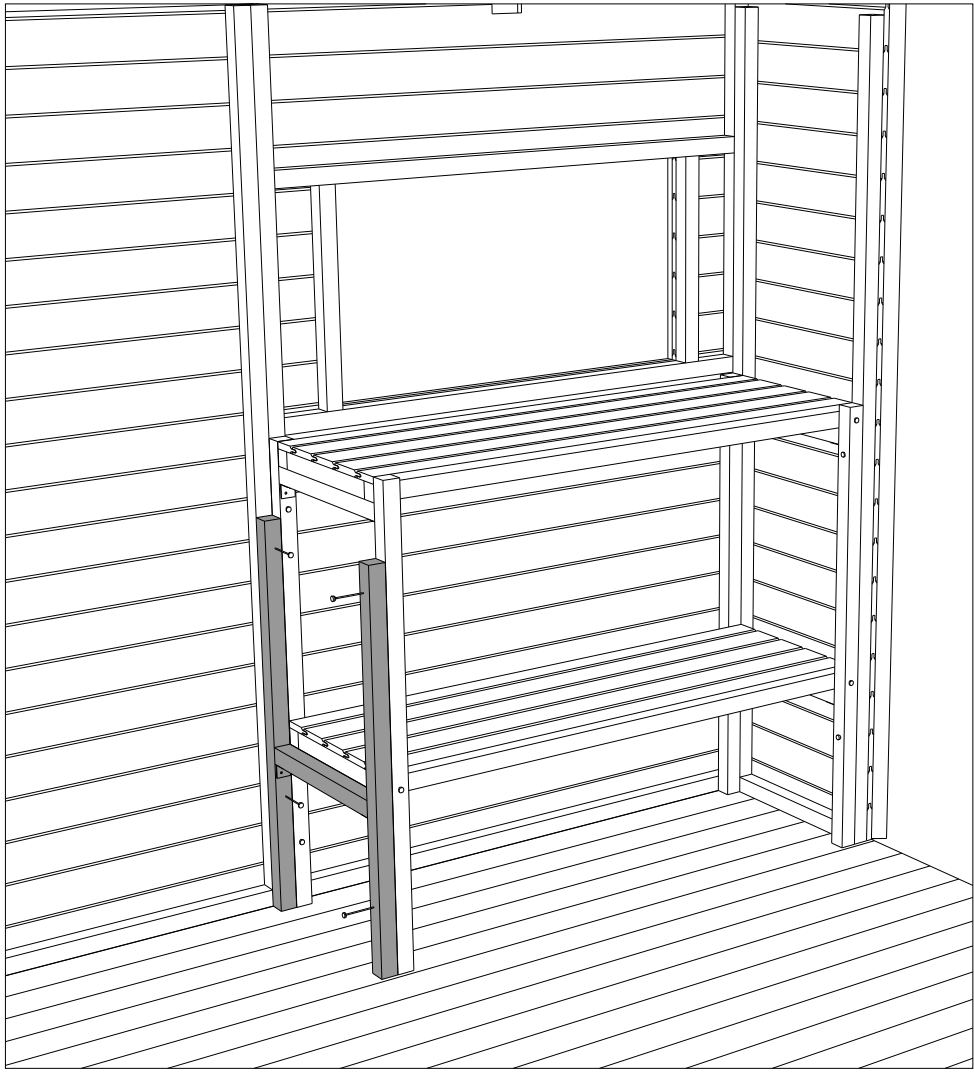

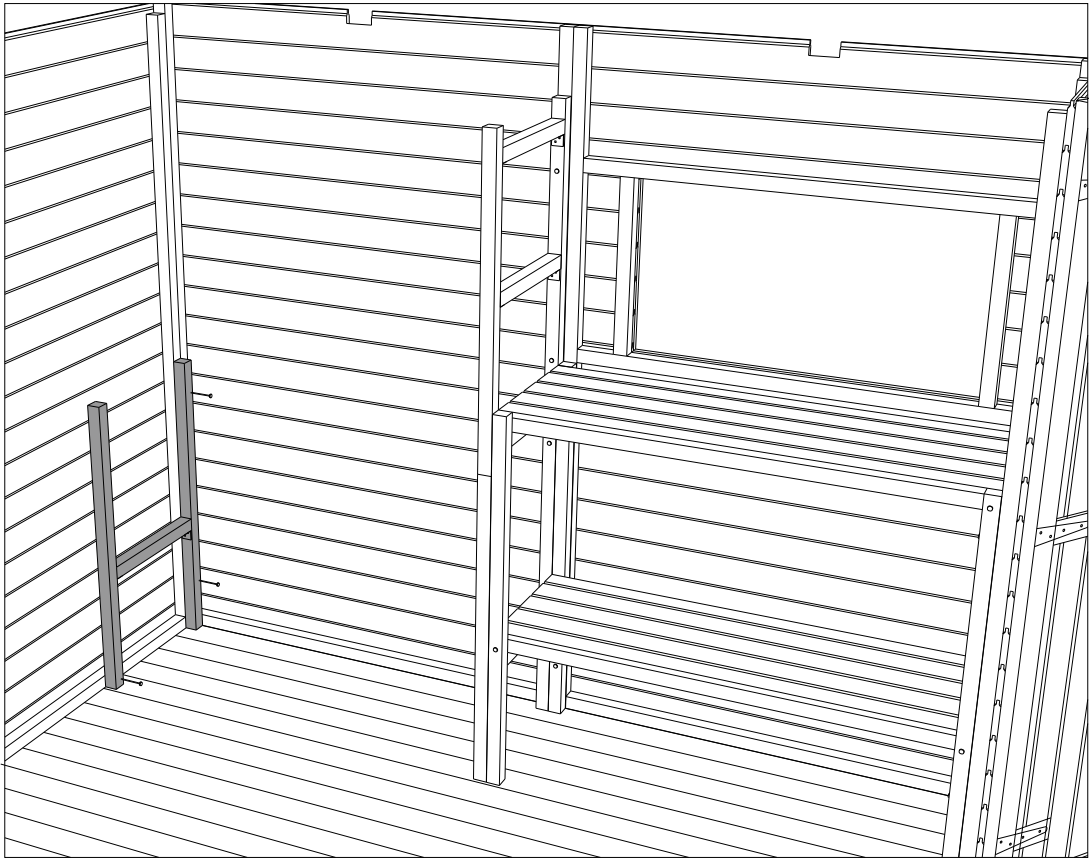

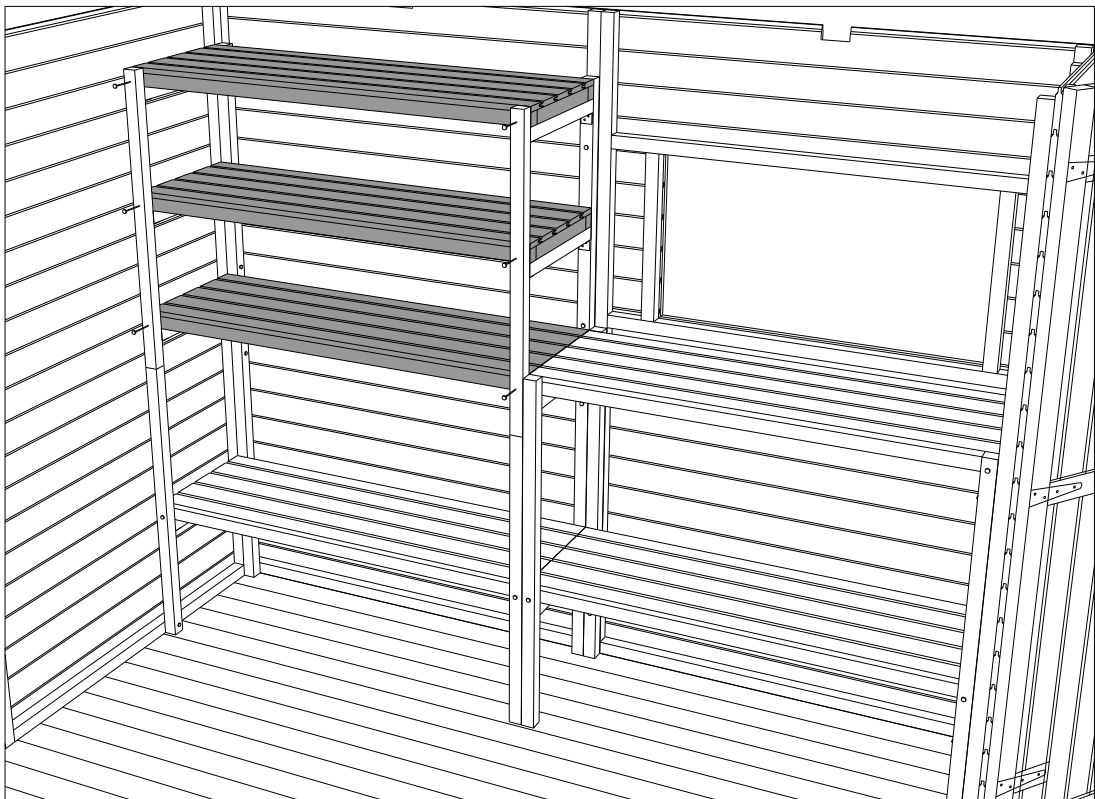
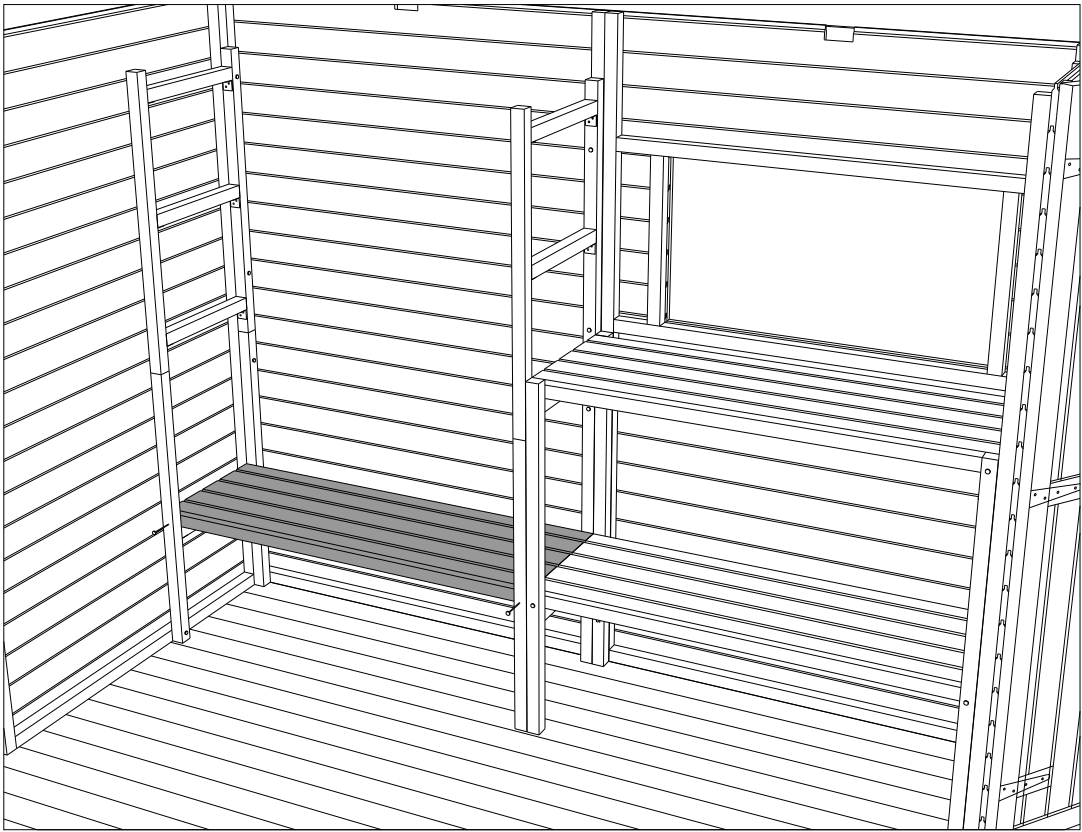

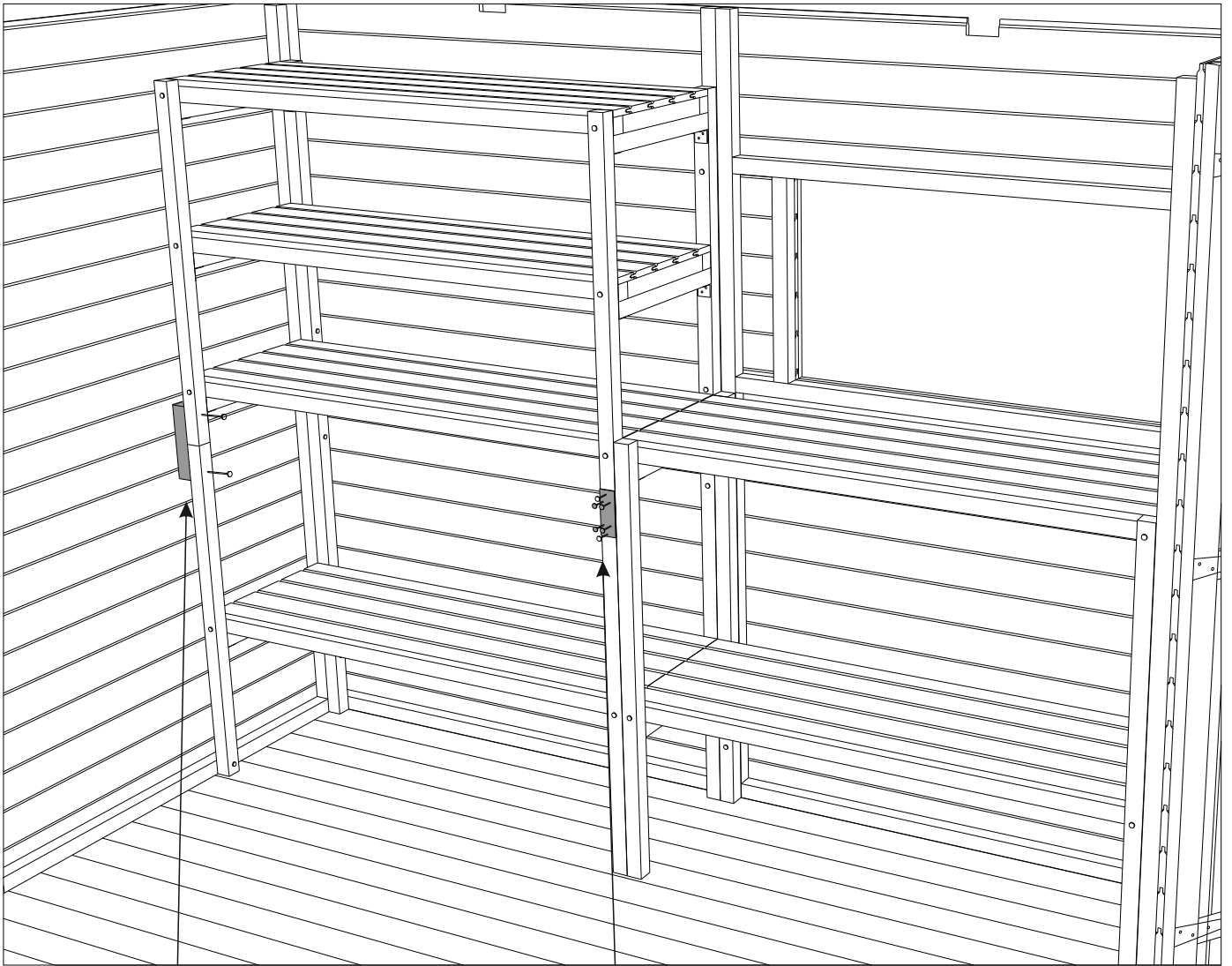

D



C

