

## Pergola 160x249x72

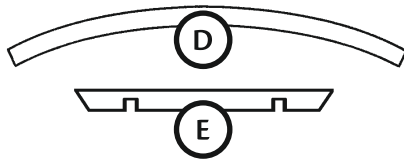

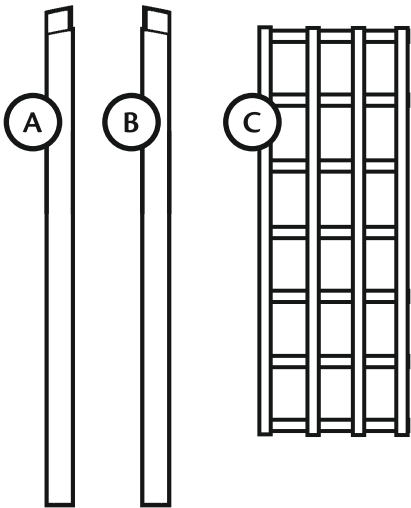

**PARTS LIST**

|                         |     |
|-------------------------|-----|
| <b>(A)</b> Posts        | x 2 |
| <b>(B)</b> Posts        | x 2 |
| <b>(C)</b> Side Panels  | x 2 |
| <b>(D)</b> Roof Beams   | x 2 |
| <b>(E)</b> Roof Rafters | x 5 |

**HARDWARE PACK**

|  |                           |     |
|--|---------------------------|-----|
|  | <b>[w]</b> 4 x 50 csk     | x10 |
|  | <b>[x]</b> 8 x 40 csk     | x16 |
|  | <b>[y]</b> 3.5 x 17       | x32 |
|  | <b>[z]</b> Metal Brackets | x 8 |

**BEFORE YOU START**

- Check the pack/s and make sure that you have all of the parts listed above. If not, contact your retailer who will be able to help you.
- When you are ready to start, make sure you have the right tools to hand, plenty of space and a clean, dry area for assembly.  
It is advisable for two people to carry out the work

**SITE PREPARATION**

Excavate a 30cm square hole (approx) for each post to a depth of at least 30cm. (see Fig.A right)  
This will give your structure adequate stability.

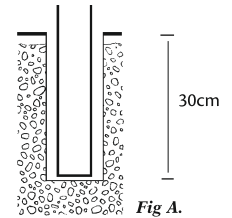

1. Begin with the roof assembly.
2. Mark off five points along the length of each of the curved beams where the rafters will be fitted (see Fig.1). It is recommended that the centre is marked first (1) and the other points measured from it.

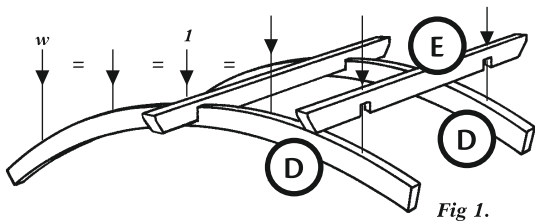

3. Fix the rafters to the curved beams using screws (w) from the top side of the rafters into the curved beams.

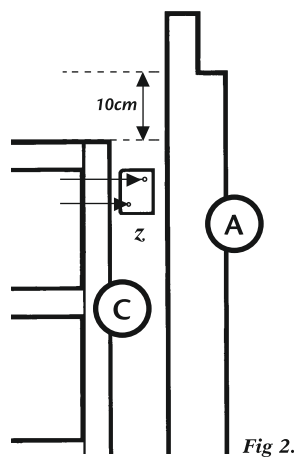

4. Use the Trellis Sections (C) to mark where the Metal Brackets (z) need to be fitted to the posts. The metal brackets should be positioned so that they fit into the corners of the trellis. The top brackets should be 100mm below the shoulder at the top of the post (see Fig.2).

5. Fit the trellis to the metal brackets using screws (y). NB. Check the posts are the correct way around so that they fit inside the roof curved beams (see Fig.3).

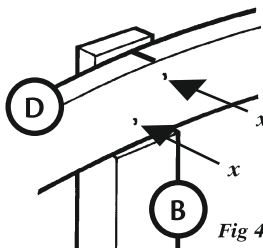
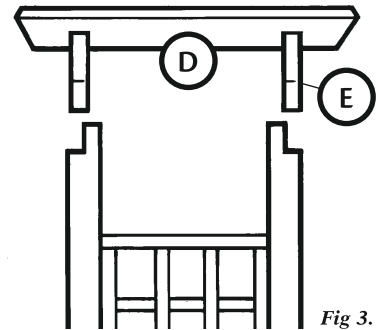

6. Fit the roof assembly onto the posts of the side assemblies and fix at the desired position with screws (x).

Make sure the overhang at each end is the same.

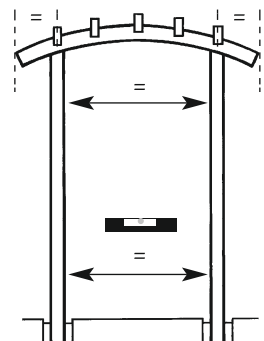

**AFTERCARE**

To ensure longevity of your structure it is recommended that it is treated with a wood preservative on a yearly basis.